

Panasonic

ideas for life

50 Hz

4/2011

Multi-format Live Switchers

AV-HS450
AV-HS400A

Compact Live Switcher
AW-HS50

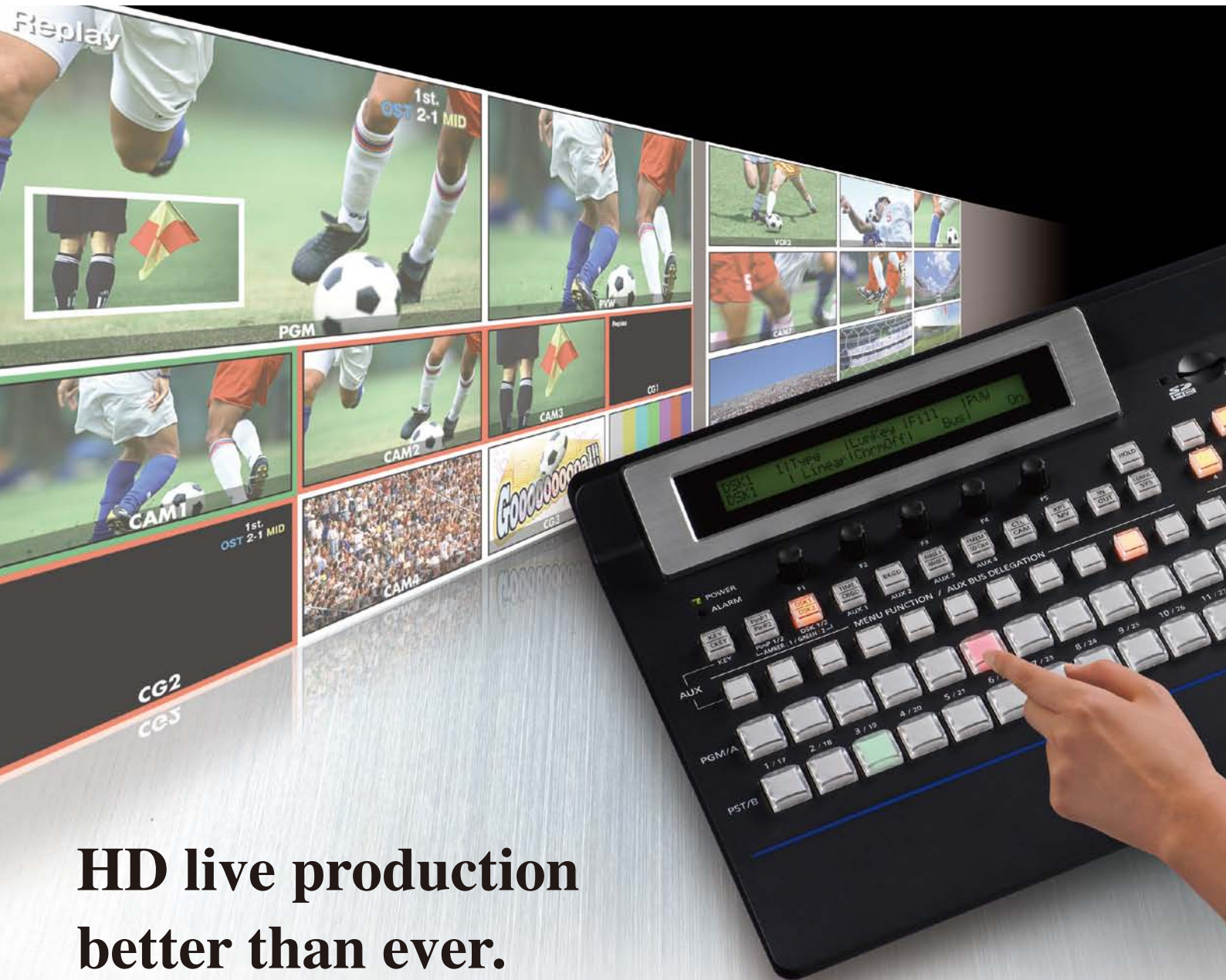

**HD live production
better than ever.**

● Multi-format Live Switchers

● Compact Live Switcher



AV-HS450



AV-HS400A



AW-HS50

Advanced broadcast quality HD technology in a A global line-up suitable for a myriad of applications.



Multi-purpose Camera
AK-HC1800
AK-HC1500



HD Convertible Camera
AW-HE870



HD/SD Integrated Camera P/T
AW-HE100



HD Integrated Camera
AW-HE50S



P2HD
Memory Card
Camera-Recorder

AV-HS400A

HD 1080/59.94i,50i,
720/59.94p,50p

SD 480/59.94i,576/50i

An all-in-one, 1ME switcher supplied with a MultiViewer, dual 3D-DVE, AUX Bus, and much more.

The HS400A is equipped with four HD/SD-SDI inputs and three outputs, and expandable to eight-in and seven-out.

Standard equipment includes PinP (Picture in Picture), Chroma Keyer and DSK (Downstream Keyer), Frame Sync, PTZ camera control, SD Card, and Ethernet Graphics Transfer.



10 Split Pictures



**Multi-format
HD/SD compatibility
for worldwide use**

Compatibility with various HD/SD formats will help you meet changing production needs as video production shifts towards HD on a global scale. You can also use optional cards to combine a variety of HD and SD signals in a flexible system, as you make a smooth transition from SD to HD.



compact size.

3D
PROFESSIONAL



AV-HS450

HD 1080/59.94i, 50i, 24PsF*, 23.98PsF*, 720/59.94p, 50p

SD 480/59.94i, 576/50i

* AV-HS04M1, M2, M3, M4, M5, M6, M7, M7D, and M8 cards do not support 24PsF or 23.98PsF.

HD switcher with 16 SDI inputs, 4 SDI outputs, 2 DVI outputs, and Dual-screen MultiViewer as standard equipment.

Expandable to 20 inputs or 10 outputs, this powerful 2-piece switcher includes a wide range of standard functions, including dual PinP, dual DSK, dual channel 3D DVE, four AUX busses, shot and PinP memories, a powerful chroma keyer, PTZ camera control with preset memories, dual redundant power supplies and much more.



16 Split Pictures

Can simultaneously display up to 20 windows on two screens.



4 Split Pictures

AW-HS50

HD 1080/59.94i, 50i, 24PsF, 23.98PsF, 720/59.94p, 50p

SD 480/59.94i, 576/50i

Compact, yet multi-functional.

Comes with a MultiViewer display function for professional HD production.

A digital video switcher equipped with 4 SDI inputs, 1 DVI-D input, 2 SDI outputs and 1 DVI-D output.

Despite its compact half rack size, the switcher provides professional HD production with its built-in MultiViewer display function, which lets you select from 8 split-screen patterns, and frame synchronizer.



5b Split Pictures



**Built-in
Frame Synchronizers
suitable for field operation**

Each input features a built-in high-performance 10-bit Frame Synchronizer. You can also smoothly switch asynchronous video signals without experiencing shock or freeze. It is also compatible with the reference (black burst) signal input, so you can synchronize with external systems (excludes AW-HS50).



Versatile inputs/outputs and dual-screen Multi



Control panel

Multi-format Live Switcher **AV-HS450**



Mainframe

Built-in 4 up-converters and 8 color correctors. Also comes with redundant power supply.

The compact 2RU mainframe size switcher is standardly equipped with 16 HD/SD-SDI input channels. All inputs feature a built-in Frame Synchronizer. It is also mounted with 4 up-converters and 8 color correctors. Its standard output configuration includes 4 HD/SD-SDI output channels and 2 DVI-D output channels. In addition, it features 4 Aux busses*1, and the Aux 1 comes with a MIX transition function. In combination with mix effects, the switcher enables a flexible production workflow, and the redundant power supply ensures smooth field operation.

*1 Embedded audio on SDI input signals can be passed through PGM, PVM, and MV.

An extensive range of inputs and outputs will help you build a versatile system.

Excellent performance in various situations from broadcasting, entertainment, to education.



News Magazine Show



Sports Arena



Education



Halls / Theaters

Built-in dual-monitor multi display function with up to 20 windows.

Standardly equipped with a dual-monitor multi display function. A maximum of 20 channels including program (PGM), preview (PVW), and input video signal can be simultaneously displayed on 2 screens. The exclusive feature lets you work comfortably with only two monitors, even at large-scale events.



4, 9, 10 and 16 split-screens can be selected.

Audio level meters (group 1/ 1 ch, 2 ch) can be displayed on each split screen.

A maximum of 20 channels may be simultaneously displayed on 2 screens.



4 Split Pictures



16 Split Pictures



10 Split Pictures



9 Split Pictures



Viewer for powerful, cost effective production.

Standard configuration includes dedicated hardware for 2 DSK and 2 PinP channels.

The built-in upstream keyer includes luminance and chroma key functions. The HS450 chroma keyer employs the powerful Primatte algorithm, previously only available for use with high-end non-linear editing systems. Widely used in motion picture and TV production, incorporation of Primatte's algorithm into the HS450 now provides easy to adjust, high-precision compositing technology for live production. In addition, the switcher comes equipped with dedicated hardware for 2 DSK and 2 independent channels of picture-in-picture.

- Primatte® is a registered trademark of IMAGICA DIGIX Inc.
- The copyrights of Primatte® belong to IMAGICA DIGIX Inc.
- The patents for Primatte® belong to IMAGICA DIGIX Inc.

Enhanced shot memory and PinP memory for streamlined operation.

You can store up to 10 memorized image states for background transition pattern, PinP size, position and border width. The switcher is also equipped with an effect dissolve function*2. These enhanced memory functions enable a smoother and more intuitive production workflow.

- *2 You can smoothly switch from the current image to the image or operation store in the SHOT memory.

A wide range of 2D and 3D effects enhance creative expression.

In addition to standard wipe, mix, and cut transitions, powerful 2D and 3D DVE effects such as squeeze, slide, rotation, and page turn are now available. Dual channel DVE effects are also available for dramatic key effects and other creative transitions. Useful new effects include variable mosaic and selectable defocus.

Superior PTZ camera system control with preset recall and save functions.

The HS450 offers advanced control of Panasonic pan-tilt camera systems*3, including the AW-HE100 HD integrated PTZ camera. You can control one camera via direct serial connection, or up to 5 in conjunction with system controllers*4. Up to 10 preset positions may be stored or recalled for each camera.

- *3 Compatible models: AW-PH400/AW-PH405/AW-PH360.

- *4 Compatible models: AW-RP655/AW-RP555.

Embedded with high-grade chroma key technology

By matching transparent materials such as silk and glass to the background color, the superb spill removal function produces natural, realistic results. Reproduces details of elaborate content such as hair with great precision.

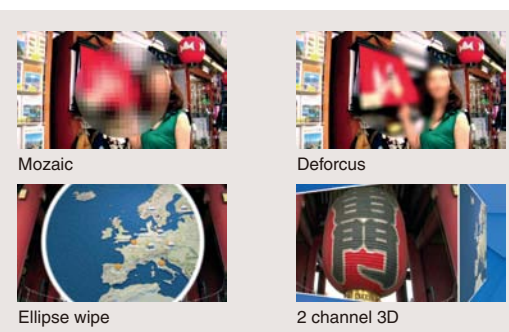
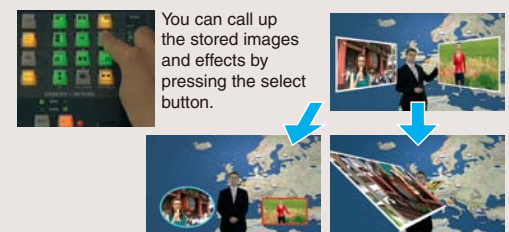

Control camera and pan-tilt systems right from the switcher to easily capture perfectly framed video.

Using the AV-HS04M7D Option Board Enables

2D/3D Switchable 3D SDI Output Board

When the AV-HS04M7D and V2.0 Software are installed in the AV-HS450, they enable the switcher to process 3D, stereoscopic video. The AV-HS04M7D also can function as a normal HD output board and, through use of its built-in downconverters, can provide SD output as well.



3D SDI Output Board **NEW**
AV-HS04M7D (for AV-HS450)
 OUTPUTS : HD/SD-SDI x2
 (Each one has 2 outputs) (BNC)
 (Built-in Down-converter)

Up to nine pairs of inputs in 3D

In 3D mode, up to nine stereoscopic cameras and other sources can be employed. Two Channel, simultaneous video cuts, dissolves, wipes and other transitions are easily performed for use in 3D production of sports, live entertainment, and other immersive content.

Compatible formats for AV-HS04M7D

2D MODE 1080/59.94i, 1080/50i, 720/59.94p, 720/50p,
 480/59.94i, 576/50i

3D MODE 1080/59.94i, 1080/50i, 720/59.94p, 720/50p

Setting the Crosspoints

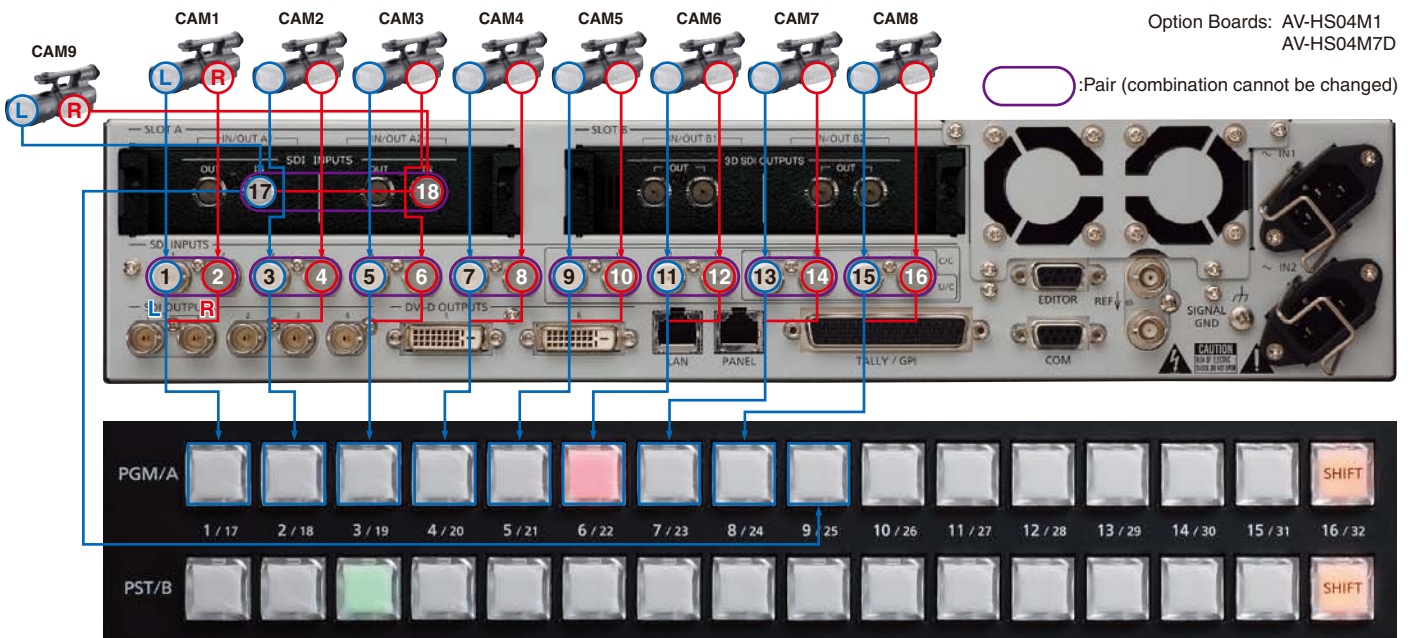

Option Boards: AV-HS04M1
 AV-HS04M7D

○: Pair (combination cannot be changed)

Mixed Outputs Facilitate 3D Adjustments

LRMIXa (LR mix a):

The L ch and R ch images are mixed, and the mixed images are output on a single channel for quick checking of convergence on a 2D monitor.

LRMIXb (LR mix b):

Magenta is mixed within the L ch LRMIXa image and green is mixed within the R ch LRMIXa image, and the images are output for rapid assessment of plus and minus convergence.

LRDiff (LR difference display):

The luminance components of the L ch and R ch images are compared, and the difference between them is displayed using a gray scale. Using the R ch image as the reference, the parts of the L ch image with a higher luminance are displayed brightly while the parts of the same image with a lower luminance are displayed dimly. Parts where the luminance of the L ch and R ch images is identical are displayed using 50 % gray.

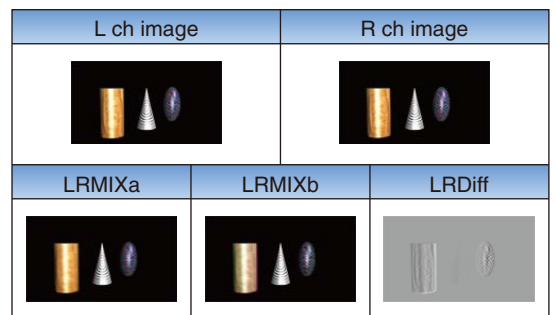

3D correction function

Vertical/horizontal reversing and position correction are possible for all 16 channels of SDI standard inputs. Position correction does not include blanking correction, and so is not intended for program distribution.

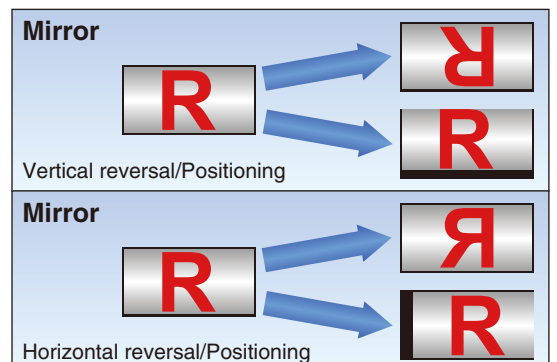

3D Video Production on the AV-HS450.



Ten Split Pictures (LRMIXa Image)

Stereoscopic 3D chroma key compositing

Extraordinary 3D stereoscopic chroma keying can be achieved onsite, in real time, using the embedded multi-layer Primatte® compositing firmware.

- Primatte® is a registered trademark of IMAGICA DIGIX Inc.
- The copyrights of Primatte® belong to IMAGICA DIGIX Inc.
- The patents for Primatte® belong to IMAGICA DIGIX Inc.

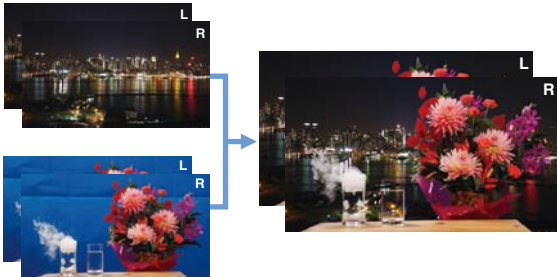

3D video signal status monitor displays

The 3D video and 3D video signal status monitor can be displayed together in PGM output and PVW output of the multi-view display (1/4 size only), enabling smoother 3D switching while checking the “protrusion” and “depth” differences between PGM and PVW. Additionally, this screen can be fed back to the camera side, and adjustments such as the brightness and horizontal/vertical positioning correction can be easily applied. These functions may be particularly useful when used to provide visual feedback to camera and rig operators.

- Distribution of Lch and Rch signal components
Lum, Red, Green, Blue

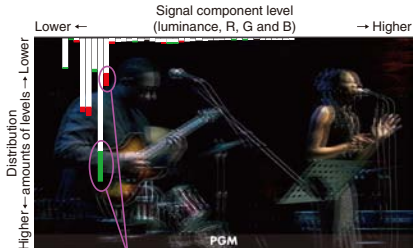

Green display area:
Indicates a distribution with many L ch components.
Red display area:
Indicates a distribution with many R ch components.

- Distribution of amount of parallax in 3D images
Prllx

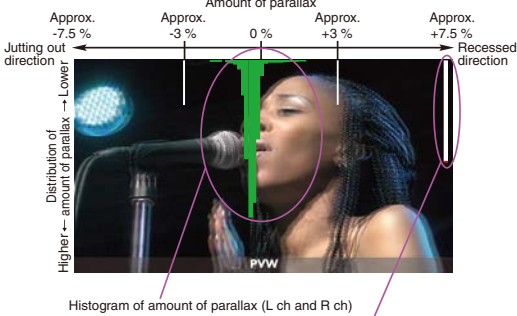

Histogram of amount of parallax (L ch and R ch)
Bar used for input signal (L ch and R ch) compensation

- A grid is displayed at intervals of about 3 % along the width of the screen.

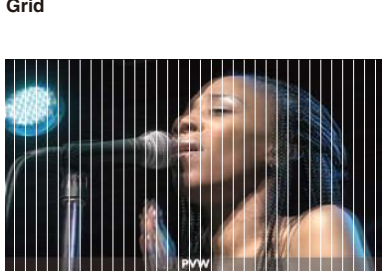

Select LRMIXa or LRMIXb as the 3D output format, and shoot so that the amount of parallax between Lch and Rch come within the grid width.

•AV-HS450 manufactured before February 2011 requires a software version upgrade to use AV-HS04M7D. Contact a local sales outlet for details. •AV-HS04M7D can only be mounted to AV-HS450 slot B. It will not operate even in 2D mode if mounted to slot A. •AV-HS04M7D is not compatible with AV-HS400/HS400A.

A compact, high-performance, global standard



Multi-format Live Switcher **AV-HS400A**

A compact switcher equipped with every function needed for great video production.

The control panel, switching circuitry, connection panel, and MultiViewer are integrated into a single compact unit, providing great portability and ease of use. The HS400A comes equipped with all the features required for high-level video production, and a simple, streamlined control panel layout makes creative switching a breeze.



The Built-in MultiViewer Can Reduce System Cost, Save Space, and Streamline Production Workflow.

Reduce the number of monitors and build an environmentally conscious system by dividing the screen to display numerous sources on a single monitor. You can edit the label of source windows, turn the labels on or off, adjust label brightness, and turn off the label background bar. You can also adjust the frame line brightness, or turn the frame lines off for use as a multi-image program display.



■ Selectable Split-screen Quantity and Location

- The window layout can be selected: 4, 8, or 10.
- Split-screen labels may be customized or selected from menus.
- Red/Green Program/Preview tally indicators may be displayed *1.
- When splitting screens into 10/8 sections, the upper 2 windows may be selected from PGM/PVW/AUX BUS/KEYOUT images.



10 Split Pictures



8 Split Pictures



4 Split Pictures

*1 The tally output connector is not compatible to green tally output.

model compatible with multi-view display.

Basic HD/SD configuration includes 4 SDI inputs and 3 assignable SDI output channels*2.

Using optional I/O boards, the HS400A can be expanded to a maximum of 8 input and 7 output channels.

The HS400A may be easily expanded to suit a wide range of applications through the use of optional input and output boards. Tally connections for up to 8 cameras are included as standard equipment, as is an RS-422 control port compatible with the basic GVG protocol.

- Optional input and output boards include:
 - Inputs: AV-HS04M1: Dual HD/SD-SDI with Up-conversion
 - AV-HS04M2: Dual HD/SD Analog Component with Up-conversion
 - AV-HS04M3: Dual Scalable DVI
 - AV-HS04M6: Dual SD Analog Composite with Up-conversion
 - AV-HS04M8: Dual DVI-D*3 compatible with WUXGA
 - Outputs: AV-HS04M4: Dual HD Analog Component
 - AV-HS04M5: Scalable DVI and HD Analog Component
 - AV-HS04M7: Dual HD/SD-SDI with Down-conversion

*2 Two interfaces assignable as PGM,PVW, AUX, multi-screen, and keyout.
 *3 AV-HS400, and AV-HS400A manufactured before January 2010 require version upgrades.
 Please contact a local sales outlet for details.

The wide range of input and output configurations are ideal for many applications.

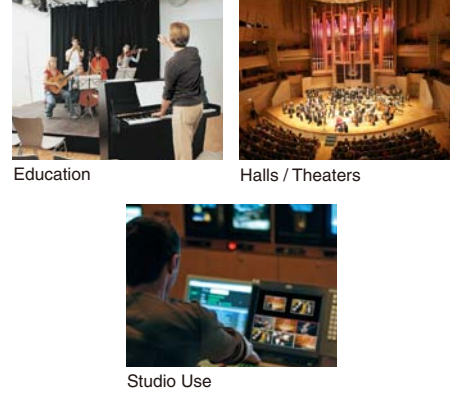

Comes with a great diversity of effects to expand your creative expression.

In addition to standard wipe patterns, you can employ slide, size-reduction, and a variety of 3D effects. 3D transitions can also be applied independently to the upstream key function, for dramatic graphic and titling effects to luminance and chroma keys. PinP and DSK functions are also included as standard equipment.

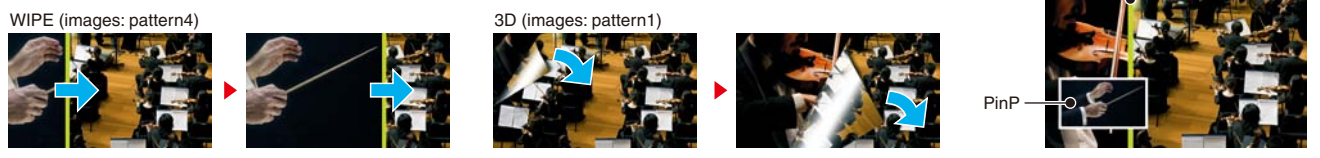

Remotely control the AW-HE100 and other Panasonic pan-tilt systems*4.

Directly connecting the AW-HE100 3CCD integrated pan/tilt/zoom camera or a Panasonic camera/pan-tilt system*4 allows control over pan, tilt, zoom, and focus using the HS400A's positioner. Moreover, by also connecting a Panasonic control panel*5 you can switch between and operate up to 5 cameras and pan-tilt heads*4.

*4 Compatible models: AW-PH400/AW-PH405/AW-PH360. *5 Compatible models: AW-RP655/AW-RP555.

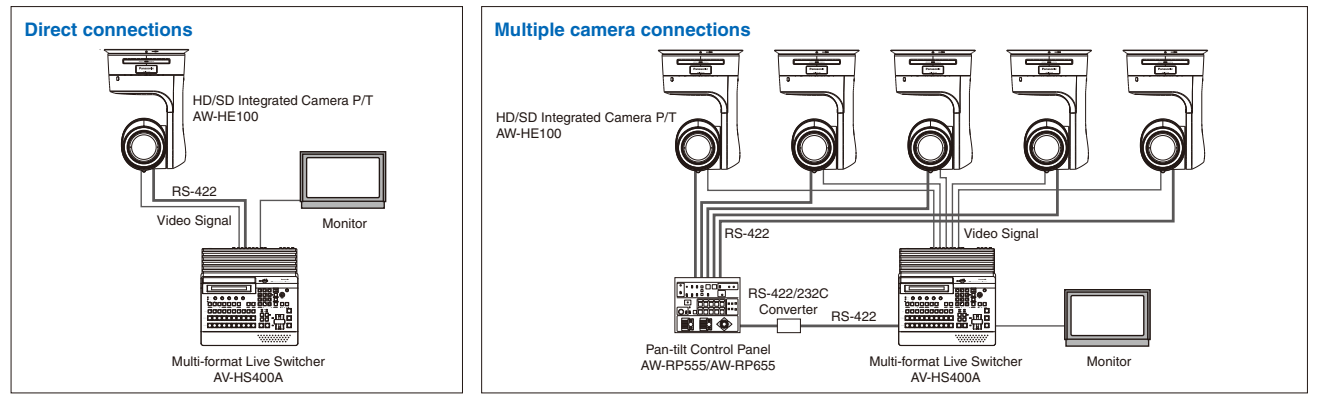

● You can upgrade the existing AV-HS400. Please contact Panasonic for more information.

AV-HS450 Controls and Functions

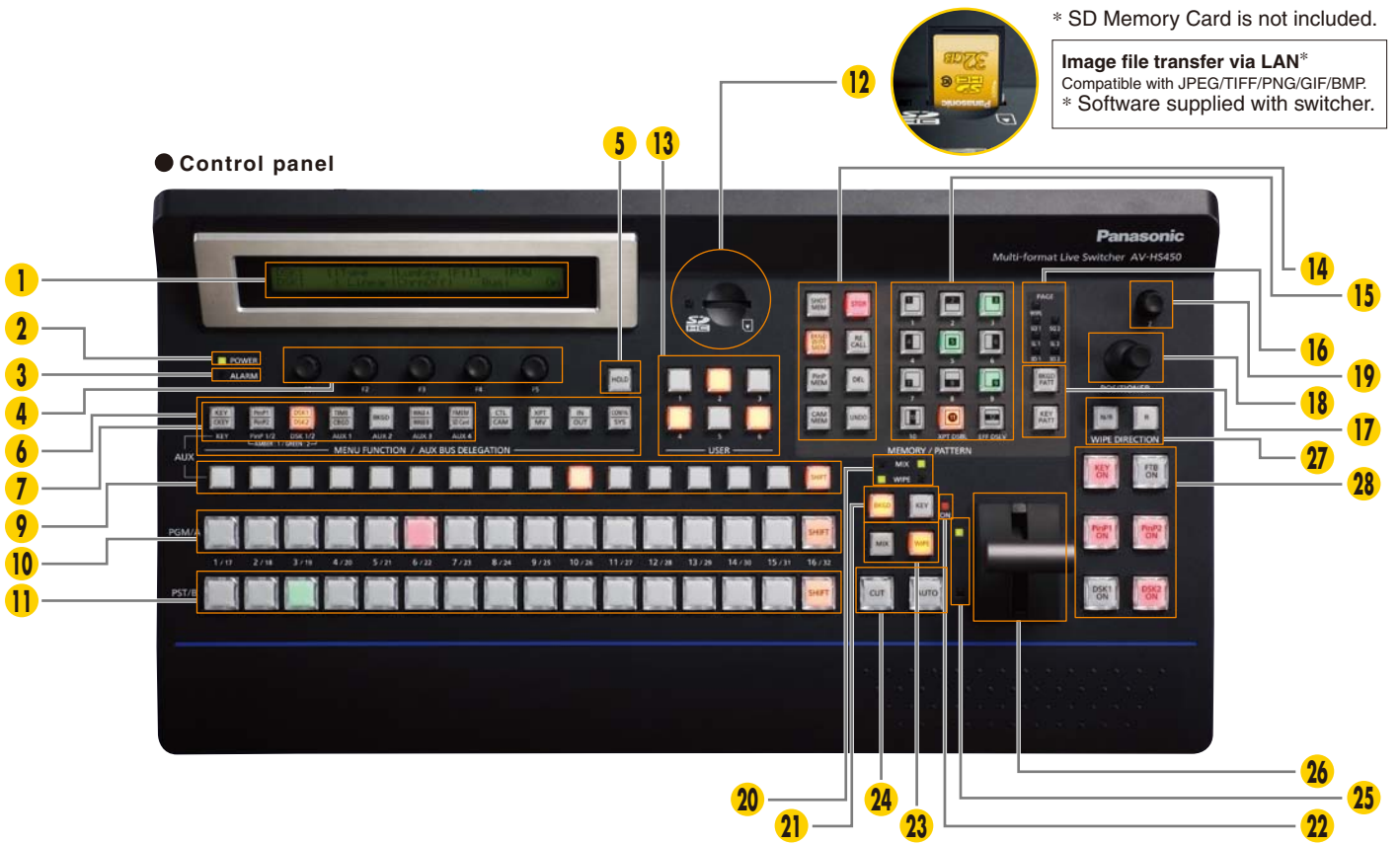

* SD Memory Card is not included.

Image file transfer via LAN*
Compatible with JPEG/TIFF/PNG/GIF/BMP.
* Software supplied with switcher.

Mainframe Rear

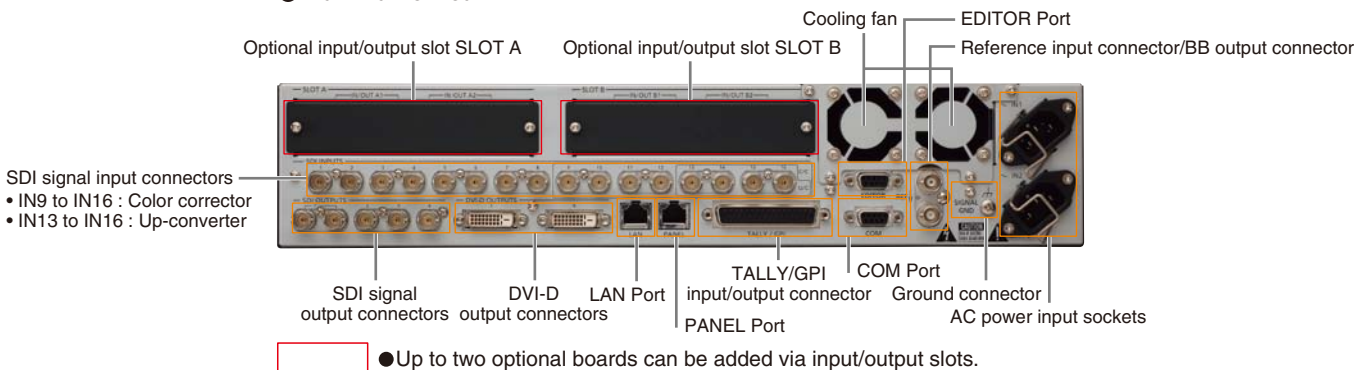

1 LCD

Displays settings menus.

2 Power indicator

3 Alarm indicator

4 Rotary encoders [F1] to [F5]

Sets parameters displayed in the menu.

5 [HOLD] button (only applies to AV-HS450)

Prohibits switching to Menu and AUX bus select buttons.

6 Menu function buttons

For direct selection of many menu functions.

7 AUX bus selector buttons

Switches AUX Bus Crosspoint button application between KEY, DSK and PinP buses.

8 AUX bus dedicated crosspoint buttons (only applies to AV-HS400A)

Selects CLN, PVW and PGM material that is selectable with the AUX bus only.

9 AUX bus crosspoint buttons

Select the source of the bus switched with the KEY/AUX Bus Cross-point row.

10 PGM/A bus crosspoint buttons

Select the PGM/A-Bus video signal.

11 PST/B bus crosspoint buttons

Select the PST/B-Bus video signal.

12 SD memory card slot

Still images (JPEG, BMP) recorded on an SD Memory Card can be used as background or key images. SD Memory Cards can also be used to store frame memory images and settings data.

- The AV-HS450 is compatible with SD/SDHC Memory Cards.
- The AV-HS400A is compatible with SD Memory Cards.

• SDHC/SD logos are registered trademarks.

13 User buttons

You can assign various menu functions to these button for one-touch access.

14 Memory operation buttons (only applies to AV-HS450)

15 Wipe pattern selector buttons

• With the AV-HS450, data can be stored in the memories of buttons 1 to 10 or recalled from these memories while one of the memory operation buttons.

AV-HS400A Controls and Functions

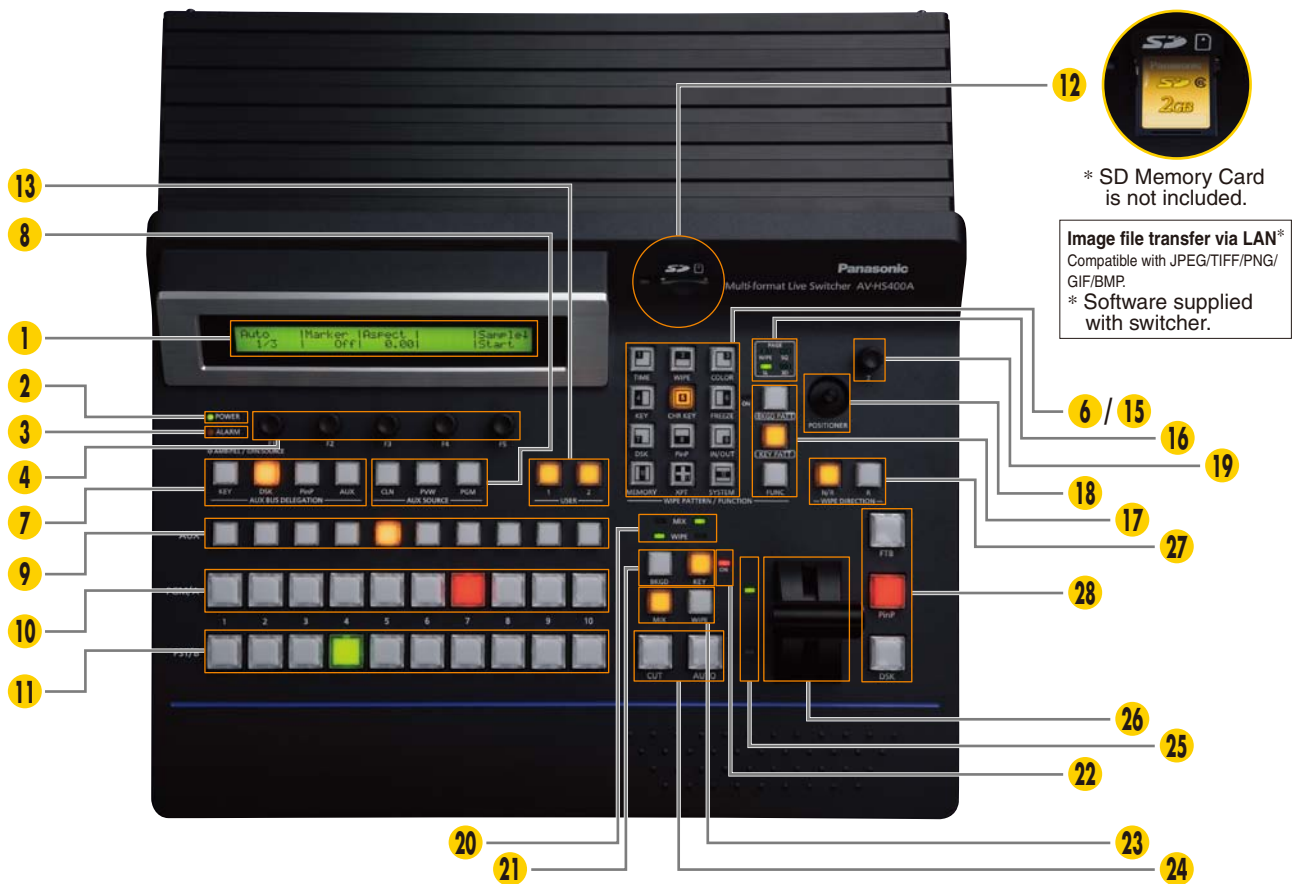

● Rear

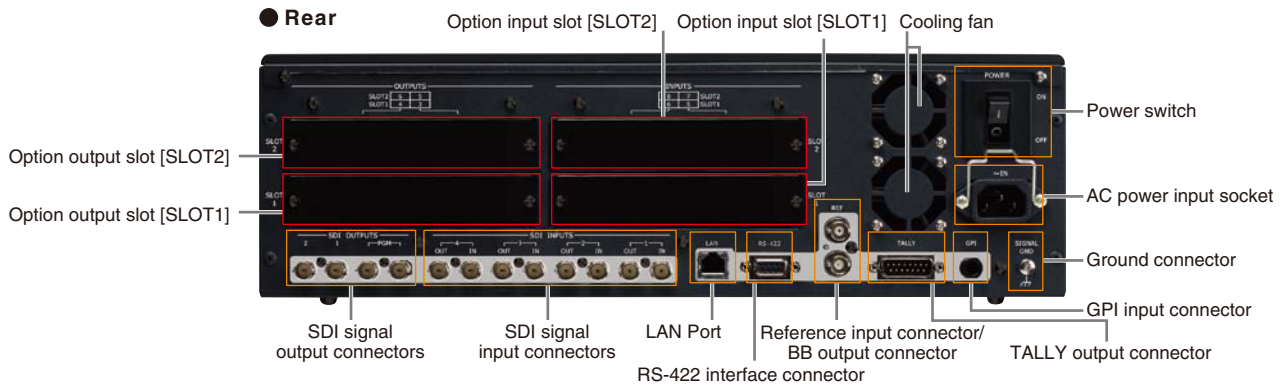

● You can add up to two optional input cards and two optional output cards via the dedicated slots.

16 Pattern page indicator LEDs

Indicates the status of the pattern page selection such as "WIPE (wipe) / SQ1 (squeeze 1) / SL1 (slide 1) / 3D1 (3 dimension 1) / SQ2 (squeeze 2) / SL2 (slide 2) / 3D2 (3 dimension 2)" for AV-HS450 and "WIPE (wipe) / SQ (squeeze) / SL (slide) / 3D (3 dimension)" for AV-HS400A.

17 BKGD,KEY pattern selector buttons

Selects from background wipe, KEY wipe or FUNCTION (only applies for AV-HS400A) for WIPE PATTERN/FUNCTION Selection buttons.

18 Positioner [X/Y]

In conjunction with the positioner (X, Y), used to set PinP and wipe location, chroma key range and other parameters.

20 MIX, WIPE selection status tally LEDs

Indicates background and KEY transition type selection status.

21 Next transition selection buttons

Select transition image from background and key.

22 KEY ON tally LED

23 Transition type selection buttons

Selects the transition type option, selected with, Next Transition selection buttons for background and KEY.

- MIX - Switches A-/B-bus images while overlapping.
- WIPE - Performs transition using the pattern selected with the Wipe Pattern Selection button.

24 Transition execution buttons

- AUTO - Executes automatic transition of a selected duration.
- CUT - Executes instant transition.

25 Bus tally LEDs

Indicates A-, B-Bus output status.

26 Fader lever

27 Wipe direction selection buttons

28 Transition execution buttons

Switches FTB (Fade-to-Black), PinP and DSK ON/OFF. With the AV-HS400A, you can disable or change the FTB to KEY ON/OFF.

AV-HS450 System Diagrams

AV-HS450

- Adding the optional board AV-HS04M7D ensures professional 3D production.

This example employs HD-SDI camera environment without Genlock.

☐ = Option Boards

① 3D SDI OUTPUTS (AV-HS04M7D)

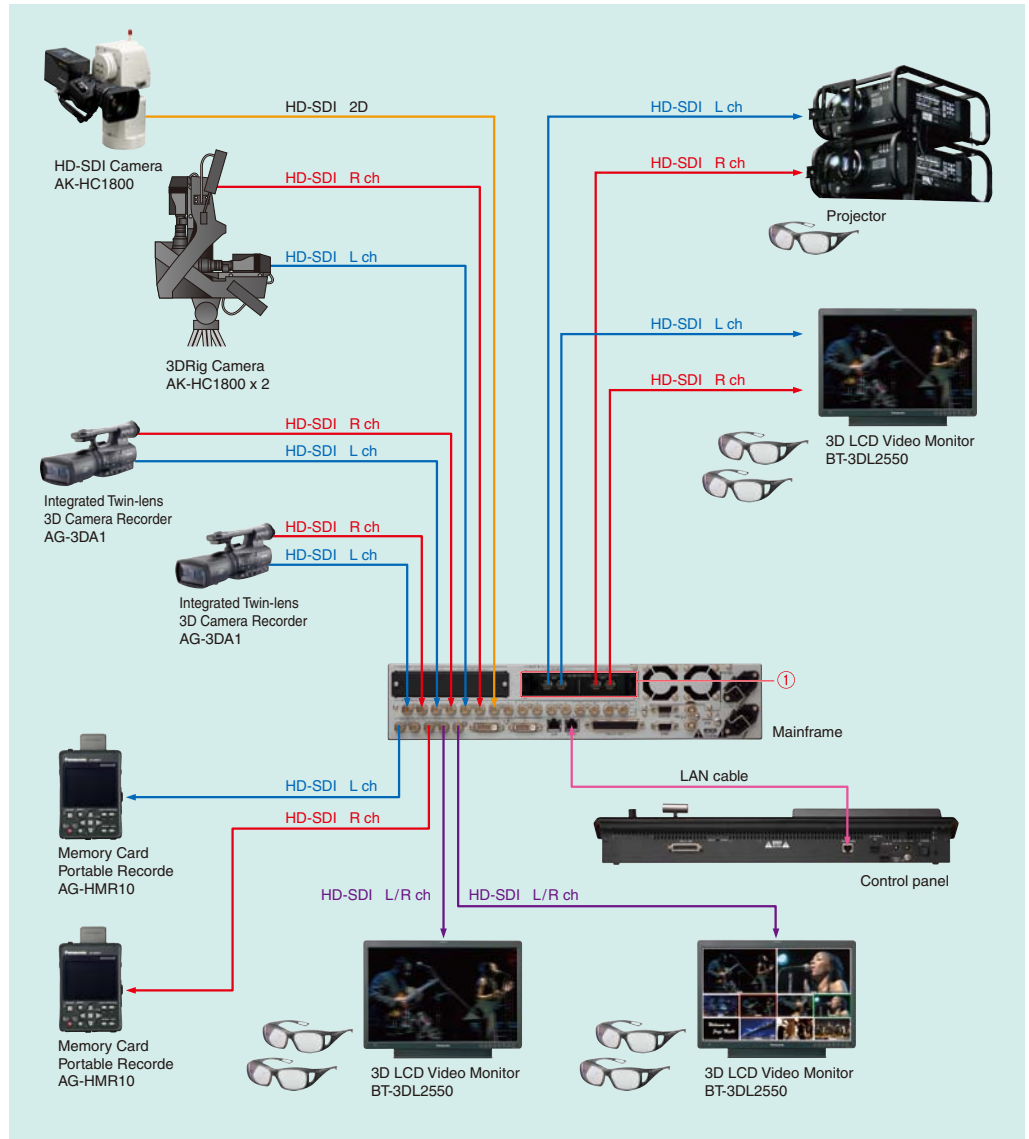

- Ideal for use at broadcast stations, production companies, as well as in mid-sized studios and production vans.

This example employs HD/SD-SDI cards for all cameras and uses an external sync generator for Genlock reference.

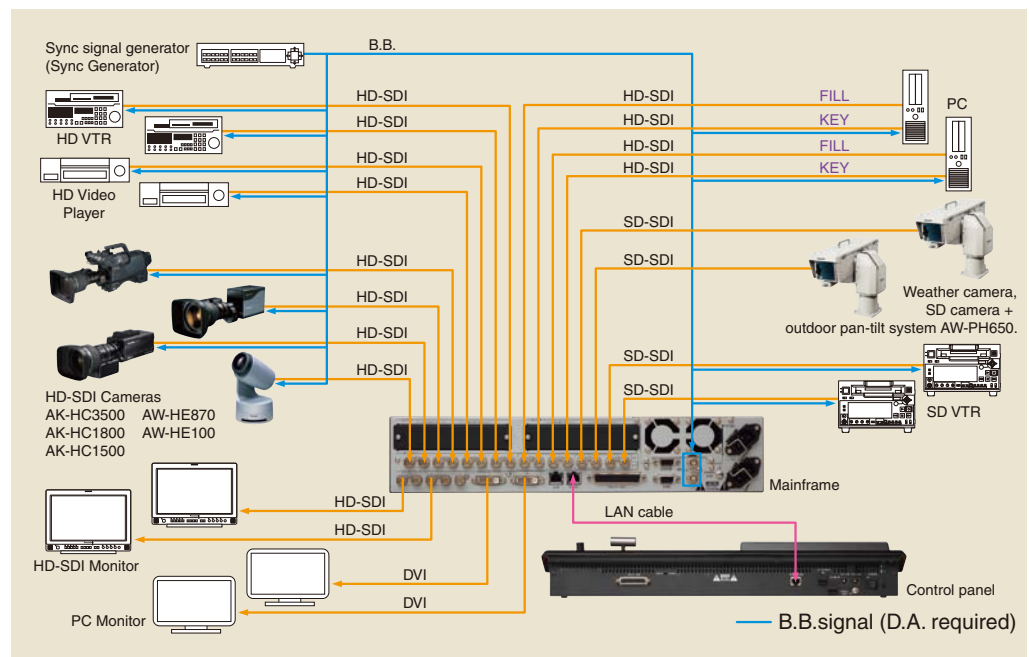

AV-HS400A System Diagrams

AV-HS400A

● Ready for broadcast and studio production applications.

This example employs HD-SDI camera environment with Genlock.

- Option Boards
- ① SDI INPUTS (AV-HS04M1)
 - ② SDI INPUTS (AV-HS04M1)
 - ③ ANALOG OUTPUTS (AV-HS04M4)

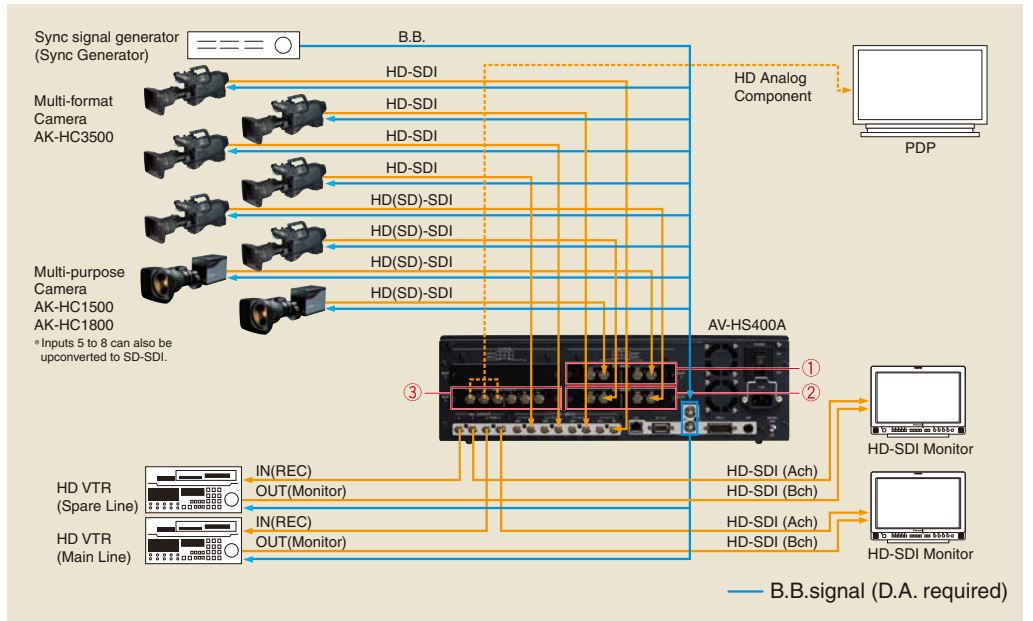

● Ideal for use with smaller systems at cable stations, schools, churches, and for mobile flypacks.

This example employs HD Analog and other option cards, and does not require Genlock.

- Option Boards
- ① DVI INPUTS (AV-HS04M3)
 - ② ANALOG INPUTS (AV-HS04M2)
 - ③ DVI/ANALOG OUTPUTS (AV-HS04M5)

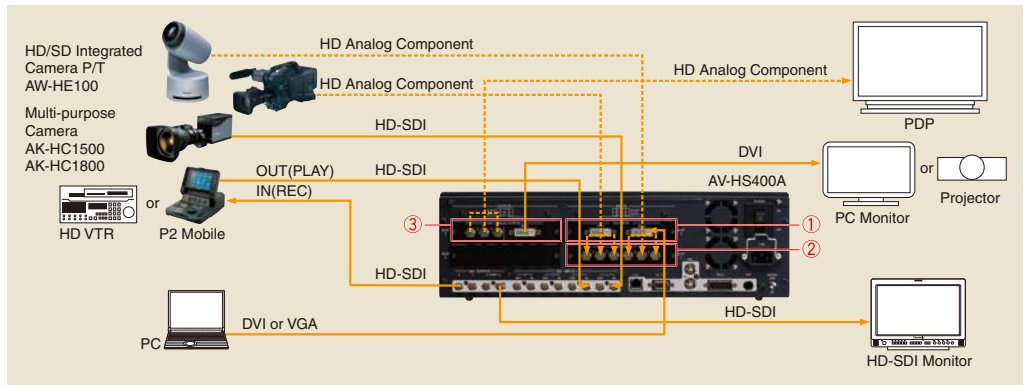

● Provides the flexibility required for facilities moving from SD to HD production.

1. A combined HD/SD-SDI and HD/SD analog component environment without Genlock.

- Option Boards
- ① ANALOG INPUTS (AV-HS04M2)
 - ② SDI INPUTS (AV-HS04M1)
 - ③ DVI/ANALOG OUTPUTS (AV-HS04M5)
 - ④ ANALOG OUTPUTS (AV-HS04M4)

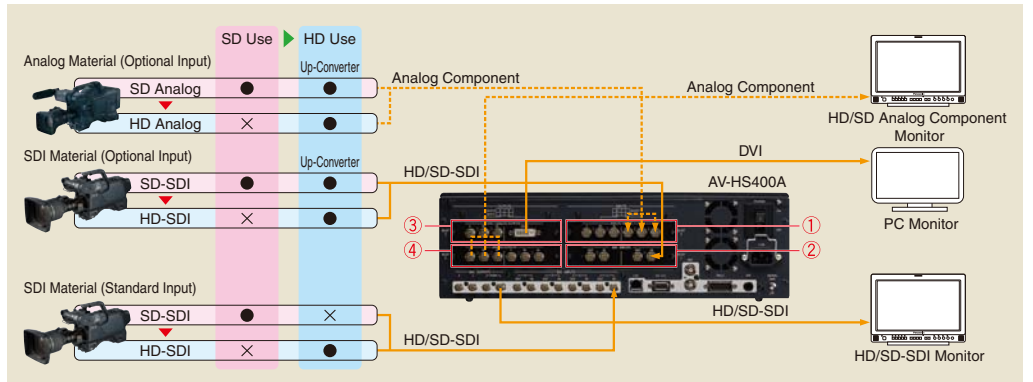

2. A combined HD/SD-SDI and analog composite environment without Genlock.

- Option Boards
- ① ANALOG COMPOSITE INPUTS (AV-HS04M6)
 - ② SDI OUTPUTS (AV-HS04M7)

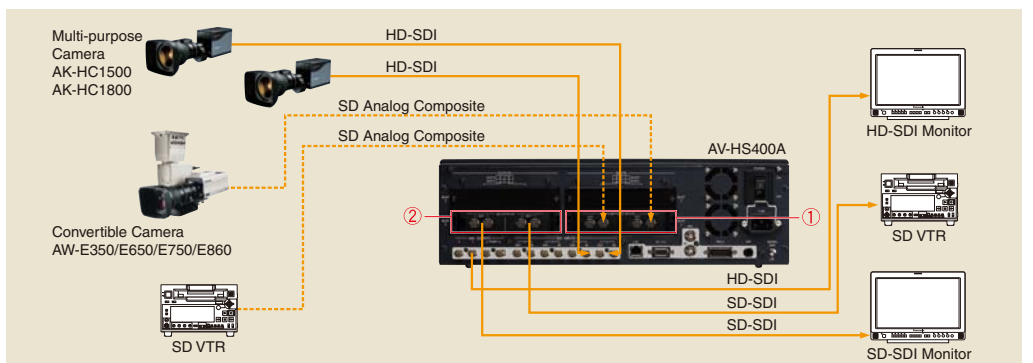

AV-HS450 / AV-HS400A Option Boards

Input/output formats compatible with the AV-HS450/AV-HS400A

		AV-HS450											AV-HS400A										
		Standard	Standard	Standard	M1	M2	M3	M4	M5	M6	M7	M7D ^{*1}	M8	Standard	Standard	M1	M2	M3	M4	*1 M5	M6	M7	M8 ^{*2}
		SDI x16	SDI x4	DVI-D x2	SDI x2	COMP x2	DVI-I x2	COMP x2	DVI-I/COMP	COMPSIT x2	SDI x2	SDI x2	DVI-D x2	SDI x4	SD x3	SDI x2	COMP x2	DVI-I x2	COMP x2	DVI-I/COMP	COMPSIT x2	SDI x2	DVI-D x2
		IN	OUT	OUT	IN	IN	IN	OUT	OUT	IN	OUT	OUT	IN	IN	OUT	IN	IN	IN	OUT	OUT	IN	OUT	IN
Analog composite	NTSC																						
	PAL																						
Analog component	480/59.94i					✓			✓	✓							✓			✓	✓		
	576/50i					✓			✓	✓							✓			✓	✓		
	1080/59.94i					✓			✓	✓							✓			✓	✓		
	1080/50i					✓			✓	✓							✓			✓	✓		
	720/59.94p					✓			✓	✓							✓			✓	✓		
	720/50p					✓			✓	✓						✓			✓	✓			
SDI	480/59.94i	✓	✓		✓							✓	✓ ^{*3}		✓	✓	✓						✓
	576/50i	✓	✓		✓							✓	✓ ^{*3}		✓	✓	✓						✓
	1080/59.94i	✓	✓		✓							✓	✓		✓	✓	✓						✓
	1080/50i	✓	✓		✓							✓	✓		✓	✓	✓						✓
	720/59.94p	✓	✓		✓							✓	✓		✓	✓	✓						✓
	720/50p	✓	✓		✓							✓	✓		✓	✓	✓						✓
	1080/24PsF	✓	✓		✓							✓	✓		✓	✓	✓						✓
	1080/23.98PsF	✓	✓		✓							✓	✓		✓	✓	✓						✓
DVI analog	XGA (1024 x 768) 60Hz						✓		✓									✓		✓			
	WXGA (1280 x 768) 60Hz						✓		✓									✓		✓			
	SXGA (1280 x 1024) 60Hz						✓		✓									✓		✓			
DVI digital (PC)	XGA (1024 x 768) 60Hz			✓					✓				✓					✓		✓			✓
	WXGA (1280 x 768) 60Hz			✓					✓				✓					✓		✓			✓
	SXGA (1280 x 1024) 60Hz			✓					✓				✓					✓		✓			✓
	UXGA (1600 x 1200) 60Hz			✓					✓				✓					✓		✓			✓
	WSXGA+ (1680 x 1050) 60Hz			✓					✓				✓					✓		✓			✓
	WUXGA (1920 x 1200) 60Hz			✓					✓			✓					✓		✓			✓	✓
DVI digital (VIDEO)	1080/59.94p			✓					✓				✓					✓		✓			✓
	1080/50p			✓					✓				✓					✓		✓			✓

✓ Compatible

Option Boards You can expand inputs/outputs to match your requirements.

- You can add up to 2 boards to the input/output option board slots of the AV-HS450, and up to 2 input and 2 output boards to the option board slots of the AV-HS400A.^{*2}

INPUTS



SDI Input Board
AV-HS04M1
INPUTS : HD/SD-SDI x 2 (BNC) (Built-in Up-converter)



Analog Component Input Board
AV-HS04M2
INPUTS : HD/SD Analog Component x 2 (Y/Pb/Pr) (Built-in Up-converter)



DVI Input Board
AV-HS04M3
INPUTS : DVI-I x 2 (Built-in Scaler)



Analog Composite Input Board
AV-HS04M6^{*4}
INPUTS : Analog Composite x 2 (Built-in Up-converter)



Full HD DVI input board
AV-HS04M8^{*2}
INPUTS : DVI-D x 2 (compatible with WUXGA)

OUTPUTS



Analog Output Board
AV-HS04M4
OUTPUTS : HD/SD Analog Component x 2 (Y/Pb/Pr)



DVI/Analog Output Board
AV-HS04M5
OUTPUTS : DVI-I x 1, Analog Component x 1 (Y/Pb/Pr)



SDI Output Board
AV-HS04M7^{*4}
OUTPUTS : HD/SD-SDI x 2 (Each one has 2 outputs) (BNC) (Built-in Down-converter)



3D SDI Output Board **NEW**
AV-HS04M7D^{*1} for AV-HS450
OUTPUTS : HD/SD-SDI x 2 (Each one has 2 outputs) (BNC) (Built-in Down-converter)

AV-HS450 / AV-HS400A Option Boards

■ AV-HS450 specifications when using AV-HS04M7D (specifications are based on AV-HS04M7D.)

Item	Function	2D MODE	3D MODE	comments		
INPUT IN 1 to 16 + [IN A1, A2]	Number of CH	16 [18] ch	(L, R) x 8 [9] ch	[] is when the optional board AV-HS04M1 was used.		
	Frame Synchronizer, Freeze	✓	✓	L, R Common Setting		
	Up-converter (IN 13 to 16)	✓	✓	L, R Common Setting		
	Color collector (IN 9 to 16)	✓	✓	L, R Separate Setting Only		
	Color correction data copy	✓	✓			
	2D camera mode (IN 1-15, [A1])	-	✓	Rch is same signal as L ch (for 2D camera)		
	Input signal reversing function (horizontal/vertical)	-	✓*5	*5 IN 1 to 16 Only When using this function, FS will be on and ANC data deleted.		
	Input signal position correction function (horizontal/vertical)	-	✓*5			
SDI OUT OUT 1 to 4 + [OUT A1 to B2]	Number of CH	6 [8] ch	6 [8] ch	[] is when the optional board AV-HS04M7 was used.		
	MODE	L, R	-	✓	Set mode for each channel.	
		MIX	-	✓		
		Side-by-Side	-	✓		
		Line-by-Line	-	✓*6		*6 Not available when DC is selected.
DVI OUT OUT 5, 6 + [OUT A2]	Number of CH	2 [3] ch	2 [3] ch	[] is when the optional board AV-HS04M5 was used.		
	MODE	L, R	-	✓	Set mode for each channel.	
		MIX	-	✓		
		Side-by-Side	-	✓*7		*7 Only standard DVI output (DVI-OUT 5, 6) can be selected (OUT A2 cannot be selected).
		Line-by-Line	-	✓*8		*8 Signals from OUT 5 and 6 are the same (OUT A2 cannot be selected).
BKGD	Trans	CUT	✓	✓		
		MIX	✓	✓		
		WIPE	✓	✓		
		DVE	✓	-		
	IMAGE A, B	✓	-			
	BORDER	✓	✓			
KEY	Number of CH	1 ch	(L, R) x 1 ch			
	Trans	CUT	✓	✓		
		MIX	✓	✓		
		WIPE	✓	✓		
		DVE	✓	✓		
	Lum, Linear, Chroma, Full	✓	✓			
	EDGE	✓	✓	Same setup data in L ch, R ch		
	MASK	✓	✓			
	FlyKEY	✓	✓			
PinP	Number of CH	2 ch	(L, R) x 1 ch			
	Mode	PinP	✓	✓	PinP over KEY (same as 2D mode) Same Position, Size, Rot, Trim sata in L ch, R ch	
		Assign INPUT	-	✓	Position, Size, Rot, Trim can be setup in Lch and R ch independently	
	Shape	Square (PinP1)	✓	✓		
		Square (PinP2)	✓	-		
		Circle (PinP1)	✓	-		
Circle (PinP2)		-	-			
DSK	Number of CH	2 ch	(L, R) x 2 ch			
	Lum, Linear	✓	✓	L, R Common Setting		
	EDGE	✓	-			
	MASK	✓	✓			
CBAR	Number of CH	1 ch	1 ch		Same CBAR in L ch, R ch	
LRmark	Number of CH	-	(L,R) x1ch	"L", "R" is displayed on black		
FMEM	Number of CH	4 ch	4 ch			
MV	Number of CH	2 ch	(L, R) x 1 ch*9	L, R Common Setting *9 16 split-screen cannot be selected.		
AUX	Number of CH	4 ch	(L, R) x 4 ch			

- 2D and 3D modes are switchable in the menu. 2D and 3D modes cannot be used simultaneously. Internal settings are reset when switching between 2D and 3D modes.
- 3D-compliant monitors are required for the monitoring in 3D.

*1 AV-HS450 manufactured before February 2011 requires a software version upgrade to use AV-HS04M7D. Contact a local sales outlet for details.

*2 AV-HS400 and AV-HS400A manufactured before January 2010 require version upgrades to use AV-HS04M8. Please contact a local sales outlet for details.
Two AV-HS04M8 boards cannot be used with AV-HS400 and AV-HS400A (you may combine other boards).

*3 3D mode is not available.

*4 AV-HS04M6/HS04M7 are for AV-HS450/HS400A. AV-HS400 requires a version upgrade to use AV-HS04M6/HS04M7. Please contact a local sales outlet for details.

Features a versatile MultiViewer display function. The compact body is also equipped with a wide range of robust functions.



Compact Live Switcher **AW-HS50**

**Comes with 5 inputs and 3 outputs as standard.
Ideal for HD production environments in a host of applications.**

An 1 M/E digital video switcher embedded with 4 SDI inputs, 1 DVI-D input, 2 SDI outputs and 1 DVI-D output that supports multiple HD/SD formats. By combining with HD integrated camera AW-HE50S or remote camera controller AW-RP50, the switcher helps save space and realizes a low-cost HD production environment.

A compact, high-performance model suitable for various business needs.



**Up to 10 channels may be displayed on a single display.
An enhanced MultiViewer display function comes as standard.**

The built-in MultiViewer display function can simultaneously display various images including program (PGM), preview (PVW) and input signals on a single monitor. The screen may be split into 4, 5a/5b, 6a/6b, 9 and 10a/10b sections.

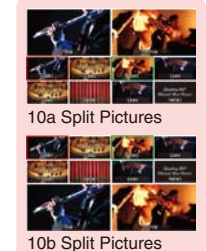
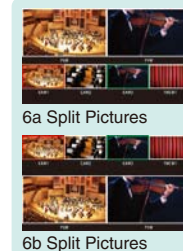
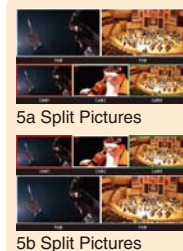
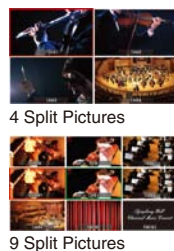

Equipped with Audio Level Meter display function.

This function displays the level of the embedded audio signals (group 1/1ch, 2ch) superimposed on the SDI input signal.



Audio Level Meter

Frame Synchronizers on All Inputs.

Frame Synchronizer is embedded in all inputs. This enables asynchronous video signals to be switched without glitches.(SDI-IN1 to 4 10 bit, DVI-IN 8 bit)

Comes with a wide range of effect functions.

Equipped with Bus Transition Functions that enable Cut and Mix transitions through PinP bus/AUX bus. The compact body comes with a wide range of functions such as 13 wipe patterns, PinP, chroma key, 2 Frame Memory channels, 2 switchable up-converters, Dot-by-Dot feature on 4 inputs, and AUX transition.



Highly efficient, stress-free operation by connecting the HD integrated camera (AW-HE50S) with the remote camera controller (AW-RP50) via IP*1.

The AW-HE50S camera setting information (iris, gain, etc.) obtained by the remote camera controller AW-RP50 can be displayed on the AUX output or on the split screens of the MultiViewer display. The switcher and remote camera controller combination realizes smooth operation by enabling switcher's ON AIR tally information to be sent to the AW-RP50 and bus images to be changed*2 according to the camera selection.

*1 Only 1 AW-RP50 may be connected to the switcher via an IP connection.

*2 Control bus targets: AUX, PVW, PinP, KEY-F

- Connection is not available with using the public network.

Controlled Via IP

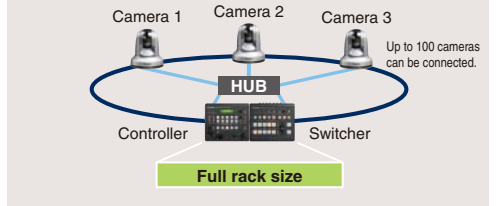

AW-HS50 Controls and Functions

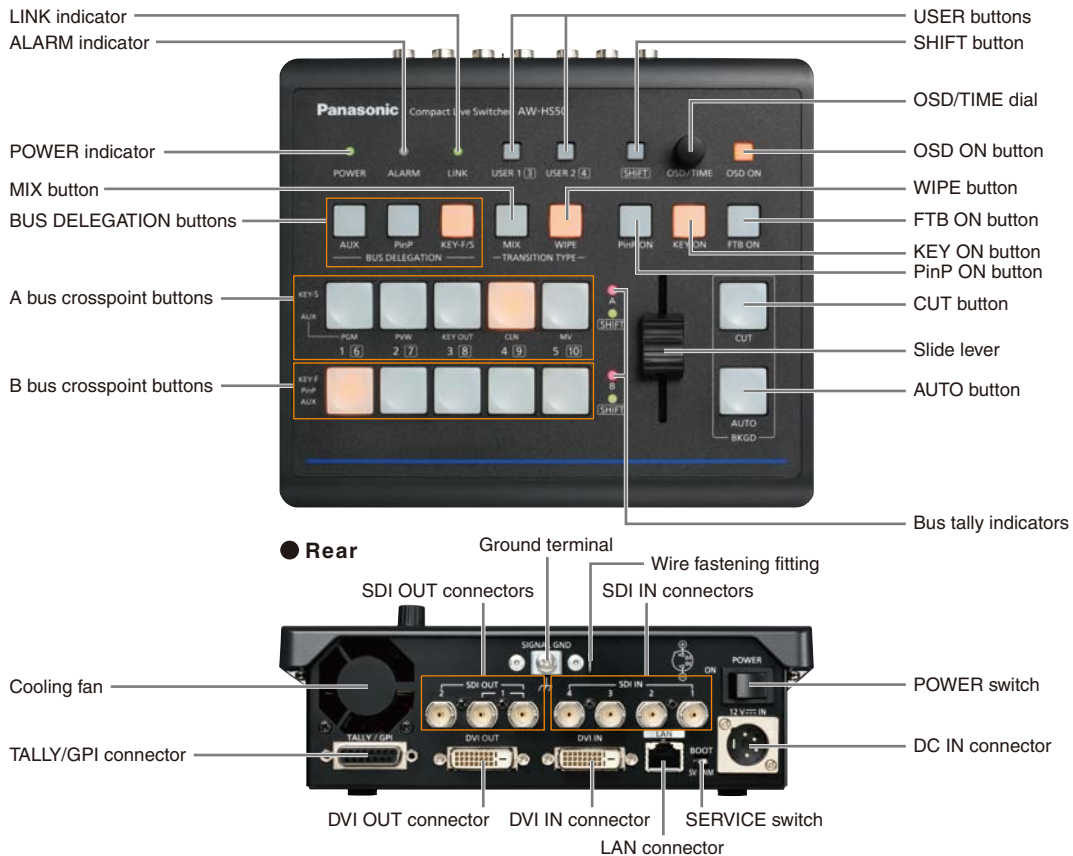

AW-HS50 System Diagrams

Compatible to small-scale shooting needs such as in-studio shootings.

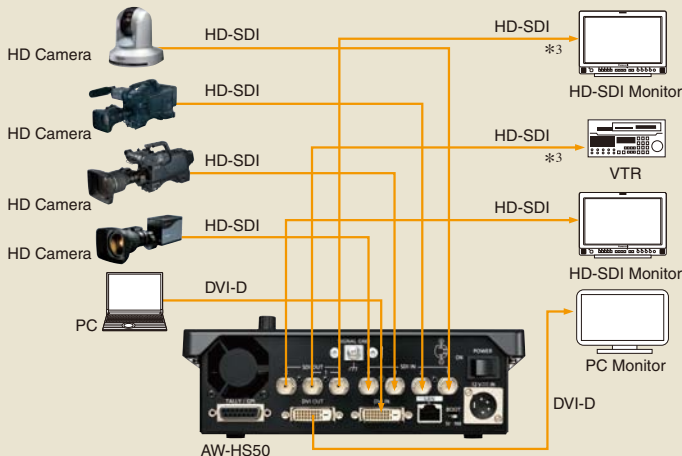

*3 The 2 signals from SDI OUT 1 are the same signals.

Saves space and enables comfortable operation of simple systems required for business use.

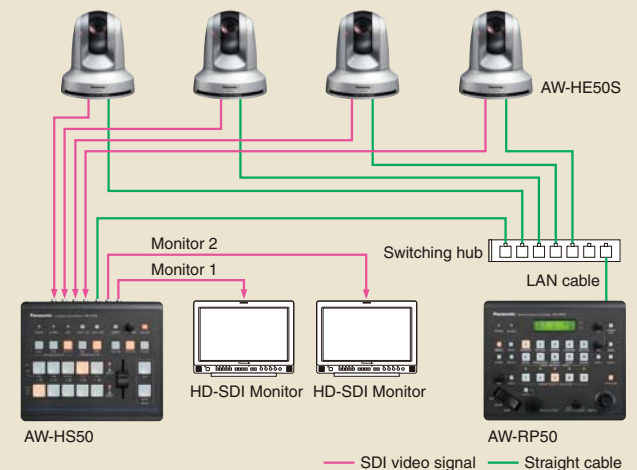

Specifications

• Mainframe

		AV-HS450 (Part number: AV-HS450U1)	AV-HS400A	AW-HS50
Video format		HD (1080/59.94i, 1080/50i, 1080/24PsF ^{*1} , 1080/23.98PsF ^{*1} , 720/59.94p, 720/50p) SD (480/59.94i, 576/50i)	HD (1080/59.94i, 1080/50i, 720/59.94p, 720/50p) SD (480/59.94i, 576/50i)	HD (1080/59.94i, 1080/50i, 1080/24PsF, 1080/23.98PsF, 720/59.94p, 720/50p) SD (480/59.94i, 576/50i)
Video processing		Y:Cb:Cr, 4:2:2 10 bit (8 bit for FMEM) RGB, 4:4:4 8 bit	Y:Cb:Cr, 4:2:2 10 bit (8 bit for FMEM) RGB, 4:4:4 8 bit	Y:Cb:Cr, 4:2:2 10 bit (8 bit for FMEM) RGB, 4:4:4 8 bit
M/E		1 M/E	1 M/E	1 M/E
Video Input		A maximum of 20 inputs Standard: 16 SDI inputs (IN 1 to 16) Optional: Maximum of 4 inputs (IN A1, A2, B1, B2) (Up to 2 optional boards may be inserted into the 2 input/output optional slots)	A maximum of 8 inputs Standard: 4 SDI inputs (IN 1 to 4) Optional: Maximum of 4 inputs (IN 5 to 8) (Up to 2 optional boards may be inserted into the 2 input optional slots) *2	Standard: 4 SDI inputs (SDI-IN 1 to 4) Standard: 1 DVI-D input (DVI-IN) XGA (1024 x 768), WXGA (1280 x 768), SXGA (1280 x 1024), WSXGA+ (1680 x 1050), UXGA (1600 x 1200), WUXGA (1920 x 1200) (Vertical frequency: 60 Hz) 1080/50p, 1080/59.94p ●Analog input signals are not supported.
Reference input		Black burst or tri sync signal input (with loop through) x 1*3 ①②	Black burst or tri sync signal input (with loop through) x 1*3 ①	-
Video output		A maximum of 10 outputs Standard: 4 SDI outputs (OUT 1 to 4 each, 2 output distribution for OUT 1) Option: Maximum of 4 outputs (OUT A1, A2, B1, B2) (Up to 2 optional boards may be inserted into the 2 input/output optional slots) Standard: 2 DVI-D outputs (OUT 5, OUT 6)*4 XGA (1024 x 768), WXGA (1280 x 768), SXGA (1280 x 1024), WSXGA+ (1680 x 1050), UXGA (1600 x 1200), WUXGA (1920 x 1200) (Vertical frequency: 60 Hz) 1080/50p, 1080/59.94p ●High-resolution multi view mode supported: When the system mode is set to SD, the DVI-D output can be output in high resolution. If this is the case, MV 1 is set for OUT 5, and MV 2 for OUT 6. MV 1 and MV 2 cannot be set for any other outputs.	Maximum 7 outputs Standard: 3 SDI outputs (OUT 1 to 2 each, PGM x 2) Optional: Maximum 4 outputs (OUT 3 to 6 each) (Up to 2 optional boards may be added to the 2 optional output slots)	Standard: 2 SDI outputs (SDI-OUT1 to 2 each, 2 output distribution for SDI-OUT1) Standard: 1 DVI-D output (DVI-OUT) XGA (1024 x 768), WXGA (1280 x 768), SXGA (1280 x 1024), WSXGA+ (1680 x 1050), UXGA (1600 x 1200), WUXGA (1920 x 1200) (Vertical frequency: 60 Hz) 1080/50p, 1080/59.94p ●High-resolution multi view mode supported: Signals are also output with a high resolution even when SD has been selected as the system mode. When the high-resolution multi view mode is enabled, MV is assigned to the DVI OUT connector, and MV cannot be assigned to the SDI OUT 1 connectors or SDI OUT 2 connector. ●Analog output signals are not supported.
Reference output		Gen-lock mode: Loop through x 1 Internal sync: black burst signal x 2	Gen-lock mode: Loop through x 1 Internal sync: black burst signal x 2	-
BKGD	Wipe/DVE pattern	Wipe x 12, Squeeze x 11, Slide x 8, 3D x 12, 2ch squeeze x 4, 2ch slide x 4, 2ch 3D x 4	Wipe x 12, Squeeze x 11, Slide x 8, 3D DVE x 12	Wipe x 13
	Transition type	Cut, Mix, Wipe (including DVE)	Cut, Mix, Wipe (including DVE)	Cut, Mix, Wipe
	Image	Image effect: PGM/A, PST/B BUS Effect: Mosaic, Defocus, Mono color, Paint	-	-
KEYER	Number of keys	1	1	1
	Key type	Linear key, Luminance key, Chroma key, Full key	Linear key, Luminance key, Chroma key, Full key	Linear key, Luminance key, Chroma key
	Transition type	Cut, Mix, Wipe (including DVE)	Cut, Mix, Wipe (including DVE)	Mix
	Wipe/DVE pattern	Wipe x 12, Squeeze x 11, Slide x 9, 3D x 12	Wipe x 12, Squeeze x 11, Slide x 9, 3D x 12	-
DSK	Number of keys	2	1	-
	Key type	Linear key, Luminance key	Linear key, Luminance key	-
	Transition type	Mix	Mix	-
PinP	Number of PinP	2	1	1
	Transition type	Mix	Mix	Mix
AUX BUS		AUX Bus 1-4 *5 *6	AUX Bus 1 *6	AUX Bus 1
Input function	Frame Synchronizer	IN 1 to 16 *7	IN 1 to 4 *8	SDI-IN 1 to 4, DVI-IN (DVI-IN is always-on)
	Freeze	IN 1 to 16 *7	IN 1 to 4 *8	SDI-IN 1 to 4, DVI-IN
	Up-converter	IN 13 to 16 *7	With optional input board *8	SDI-IN 3, IN 4
	Color collector	IN 9 to 16	-	-
	Video Processing	-	-	SDI-IN 1 to 4
Output function	Multi Viewer	2 systems Labels, Tally indication, Split-screen (the screen may be split into 4, 9, 10 and 16 sections) *9	1 system Labels, Tally indication, Split-screen (the screen may be split into 4, 8 and 10 sections)	1 system *11 Labels, Tally indication, Split-screen (the screen may be split into 4, 5a/5b, 6a/6b, 9 and 10a/10b sections)
	Other function	OSD (PVW and several MULTI outputs), phase adjustment, chroma key sample marker, down converter (SDI output board only)	OSD (PVW and several MULTI outputs), phase adjustment, chroma key sample marker, down converter (SDI output board only)	OSD [Single Screen Display: SDI-OUT 2, DVI-OUT (unshown on SDI-OUT 1)], chroma key sample marker, Audio Level Meter: SDI embedded audio (group1/ 1 ch, 2 ch)
Frame memory	4 channels ●The data for the images stored in the frame memories can be retained even when the power is turned off by saving it in the flash memory area which is incorporated inside the unit.	2 channels ●The images saved in the frame memories will be stored in the switcher RAM, so the data will be lost when the power is turned off.	2 channels *12 ●The data for the images stored in the frame memories can be retained even when the power is turned off by saving it in the flash memory area which is incorporated inside the unit.	
Memory function	Shot memory, BKGD/Wipe memory, PinP memory, Camera memory *10 ●Effect Dissolve Function	Preset memory	PinP Preset ●Effect Dissolve Function	
Interface	PANEL	RJ45, 100 Mbps x 1 (to connect to the control panel)	-	-
	EDITOR	D-sub 9 pin x 1, RS-422 (GVG protocol compatible)	D-sub 9 pin x 1, RS-422 (GVG protocol compatible), pan-tilt system control	-
	COM	D-sub 9 pin x 1, pan-tilt system control	-	-
	TALLY/GPI	D-sub 50 pin x 1 (8 IN and 31 OUT may be set)	D-sub 15 pin x 1, open collector output ø 3.5 Stereo mini jack x 1 (2 Ports)	D-sub 15 pin x 1, GPI INPUT x 5 channels (photocoupler sensing), GPI OUTPUT x 7 channels (open collector output)
	LAN	RJ45, 10 BASE-T/100 BASE-TX	RJ45, 10 BASE-T	RJ45, 10 BASE-T/100 BASE-TX
Removable media	SD memory card ●Supported by the control panel.	Capacity: Maximum 2 GB (SD Memory Card compatible) Still image file: Loading/saving, setup data: backup	-	
Power supply	AC 220 V to 240 V, 50 Hz/60 Hz / 120 W	AC 220 V to 240 V, 50 Hz/60 Hz / 98 W	DC 12 V ±10 % (AC adapter provided), 2.0 A	
Operating temperature	0 °C to 40 °C	0 °C to 40 °C	0 °C to 40 °C	
Operating humidity	10 % to 90 % (no condensation)	10 % to 90 % (no condensation)	10 % to 90 % (no condensation)	
Dimensions (W x H x D)	(2RU) 482 mm x 88 mm x 471 mm (excluding protrusions)	420 mm x 132 mm x 408 mm (excluding protrusions)	210 mm x 67 mm x 177 mm (excluding protrusions)	
Weight	Approx. 9.8 kg (without options/excluding accessories) Approx. 10.3 kg (with full options/excluding accessories)	Approx. 6.4 kg (without options/excluding accessories) Approx. 7.2 kg (with full options/excluding accessories)	Approx. 1.4 kg (without options)	
Standard Accessories	CD-ROM (Operating instructions / Image transmission software), AC adapter (for control panel), Power cable (for mainframe and AC adapter), CAT5E cable (STP, straight cable, 10 m long)	CD-ROM (Operating instructions / Image transmission software), Power cable	CD-ROM (Operating instructions / Image transmission software), AC adapter	

• Control panel

		AV-HS450 (Part number: AV-HS450C1)
Interface	Mainframe	RJ45, 100 Mbps x 1 (to connect to the mainframe)
	TALLY/GPI	D-sub 25 pin x 1 (8 IN and 8 OUT may be set)
Removable media	SD memory card	Capacity: Maximum 32 GB (SDHC Memory Card compatible) Still image file: Loading/saving, setup data: backup
	Operating temperature	0 °C to 40 °C
Operating humidity	10 % to 90 % (no condensation)	
Power supply	DC 12 V ±10 % (AC adapter provided), 0.8 A	
Dimensions (W x H x D)	560 mm x 88 mm x 299 mm (excluding protrusions)	
Weight	Approx. 3.9 kg (excluding accessories)	

*1 1080/24PsF and 23.98PsF are not compatible with optional boards AV-HS04 M1, M2, M3, M4, M5, M6, M7, M7D and M8.
*2 AV-HS400, and AV-HS400A manufactured before January 2010 require version upgrades to use AV-HS04M8. Please contact a local sales outlet for details. Two AV-HS04M8 boards cannot be used with AV-HS400 and AV-HS400A (you may combine other boards).

*3 ① Compatible with the same field frequencies of the system format.
② 1080/23.98PsF format is compatible with black burst (SMPTE318M-compliant) with 10F-ID, or tri-level sync signal.

*4 Analog output not supported.
*5 AUX BUS 1 is compatible with MIX transition.
*6 May be routed through the SDI embedded audio input.
*7 Specifications for IN A1, A2, B1, and B2 depend on the specs of the mounted optional equipment.
*8 Specifications for IN 5 to IN 8 depend on the specs of the mounted optional equipment.
*9 Maximum 20 channels may be simultaneously displayed on 2 screens.
*10 May store and recall up to 10 presets (per camera) with current Panasonic pan-tilt systems.
*11 OSD, MV frames, Labels, Tally indications, Audio Level Meters, and Camera setting information are not shown on SDI-OUT 1.
*12 OSD, MV frames, Labels, Tally indications, Audio Level Meters, and Camera setting information, for MultiViewer are not stored in the Frame Memory.

Wipe patterns

■ AV-HS450

■ AV-HS400A

WIPE

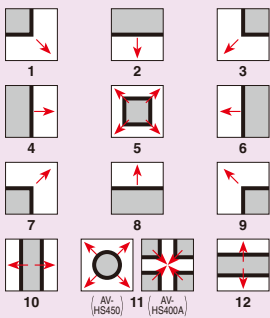

SQ (Squeeze)

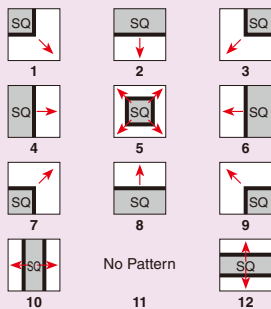

SL (Slide)

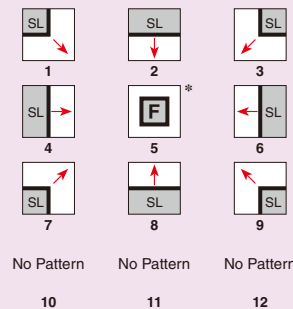

3D (3 Dimension)

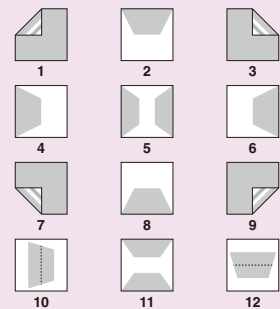

* Key transition only.

■ AW-HS50

WIPE

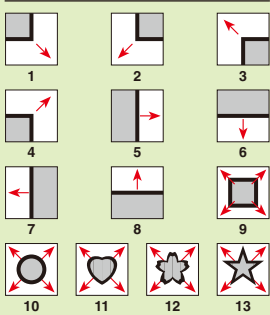

SQ2 (Squeeze2)

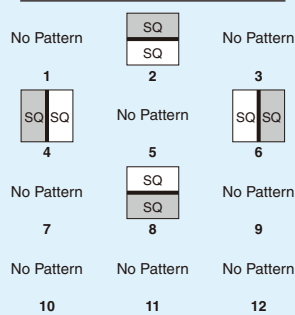

SL2 (Slide2)

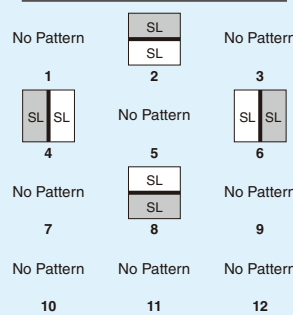

3D2 (3 Dimension2)

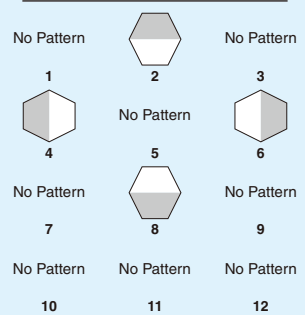

Please refer to the latest Information, etc. at panasonic web site.



<http://pro-av.panasonic.net/>

Panasonic®

Panasonic Corporation
Digital Imaging Business Group
2-15 Matsuba-cho, Kadoma, Osaka 571-8503
Japan
<http://pro-av.panasonic.net/>

[Countries and Regions]

Argentina +54 1 308 1610
Australia +61 2 9986 7400
Bahrain +973 252292
Belgium +32 (0) 2 481 04 57
Brazil +55 11 3889 4035
Canada +1 905 624 5010
China +86 10 6515 8828
Hong Kong +852 2313 0888
Czech Republic +420 236 032 552/511
Denmark +45 43 20 08 57
Egypt +20 2 23938151
Finland, Latvia, Lithuania, Estonia +358 (9) 521 52 53
France +33 (0) 1 55 93 66 67
Germany, Austria +49 (0)611 235 0
Greece +30 210 96 92 300
Hungary +36 (1) 382 60 60
India +91 120 247 1000
Indonesia +62 21 385 9449
Iran (Vida) +98 21 2271463
(Panasonic Office) +98 2188791102
Italy +39 02 6788 367
Jordan +962 6 5859801
Kazakhstan +7 727 298 0891
Korea +82 2 2106 6641
Kuwait +96 522431385

Lebanon +96 11665557
Malaysia +60 3 7809 7888
Mexico +52 55 5488 1000
Netherlands +31 73 64 02 577
New Zealand +64 9 272 0100
Norway +47 67 91 78 00
Pakistan +92 5370320 (SNT)
Palestine +972 2 2988750
Panama +507 229 2955
Peru +51 1 614 0000
Philippines +63 2 633 6163
Poland +48 (22) 338 1100
Portugal +351 21 425 77 04
Puerto Rico +1 787 750 4300
Romania +40 21 211 4855
Russia & CIS +7 495 6654205
Saudi Arabia +96 626444072
Singapore +65 6270 0110
Slovak Republic +421 (0) 2 52 92 14 23
Slovenia, Albania, Bulgaria, Serbia, Croatia, Bosnia, Macedonia, Montenegro +36 (1) 382 60 60
South Africa +27 11 3131622
Spain +34 (93) 425 93 00
Sweden +46 (8) 680 26 41
Switzerland +41 (0) 41 259 96 32
Syria +963 11 2318422/4

Taiwan +886 2 2227 6214
Thailand +66 2 731 8888
Turkey +90 216 578 3700
U.A.E. (for All Middle East) +971 4 8862142
Ukraine +380 44 4903437
U.K. +44(0)1344 70 69 13
U.S.A. +1 877 803 8492
Vietnam +848 38370280



JQA-0443



Factories of Systems Business Group have received ISO14001:2004-The Environmental Management System certification. (Except for 3rd party's peripherals.)